



PRODUCT SELECTION DATA

- Monobloc inverter
- Compact, reliable and efficient
- More than a Heat Pump



Reversible Air to Water Heat Pump

30AW

AQUASNAP
Reversible

30AW

Nominal heating capacity 4-15 kW

Nominal cooling capacity 3-16 kW

The new reversible AquaSnap PLUS air-to-water heat pumps/chillers with built-in inverter technology were designed for residential and light commercial applications. They offer excellent energy efficiency values, exceptionally quiet operation and meet the most stringent operating temperature demands.

The units integrate the latest technological innovations: ozone-friendly refrigerant R410A, DC inverter twin-rotary compressors, low-noise fan and microprocessor control.

With exceptional energy efficiency values the inverter mini-chillers qualify for local tax reductions and incentive plans in all EU countries.

The 30AW units were specifically designed for ease-of-installation and service and underline Carrier's reputation for highest product quality and reliability.

For added flexibility the AquaSnap PLUS units are available with or without hydraulic module. The AquaSnap PLUS can be used with complementary accessories to suit the installation - 80HMA Comfort modules, 200 or 300 litres domestic hot water tank with or without thermal solar panel connection.

The AquaSnap PLUS heat pump systems can be used with a wide choice of Carrier terminal fan coil units - cassettes, low, medium and high-pressure satellite units, console units, underceiling units and high-wall units.

Features

Wide operating range in both heating and cooling mode offering high performance in a wide temperature range. DC inverter twin-rotary compressors with Pulse Amplitude Modulation (PAM) and Pulse Width Modulation (PWM) for enhanced reliability, low energy consumption and smooth vibration-free operation under all operating conditions. Variable-speed fans with an innovative patented fan blade shape ensure improved air distribution at exceptionally low noise levels.

Pre-set or customised selection of the appropriate climate curve for stable output capacity to match the heat load. Output to link and integrate the unit with existing heat sources or a back-up heating source (single or dual-energy approach) for increased savings and optimum comfort all year round. Connection and control of an external dehumidifier through the Comfort™ Series programmable thermostat 33AW-CS1

to monitor and regulate the relative humidity. Input and output connections to the three-way valve for connection to a domestic hot-water buffer-tank. Provides increased flexibility for any application.

Leaving water temperature up to 60°C for radiator and domestic hot water applications.

Plug-and-play control for failsafe serviceability.

Alarm input to force the unit off for increased safety, and matching with external control systems or safety devices.

Output to operate an additional water pump for increased installation flexibility.

Advanced technology

Electronic system management: several sensors placed in key positions in the refrigerant circuit electronically detect the operational system status. Two micro-controllers receive the input from the sensors, manages them using advanced control algorithms and optimises the refrigerant flow and the functioning of all core components - the compressor, fan motors and the pulse modulation valve.

The pulse modulation valve, a bi-flow electronic expansion device, optimises the refrigerant amount in the circuit and the superheat, preventing refrigerant migration back into the compressor. This device further enhances high system performance and reliability.

The air management system, consisting of the propeller fan, orifice and air discharge grille guarantees minimised noise levels.

New patented fan blade shape and grille profile with low pressure drop

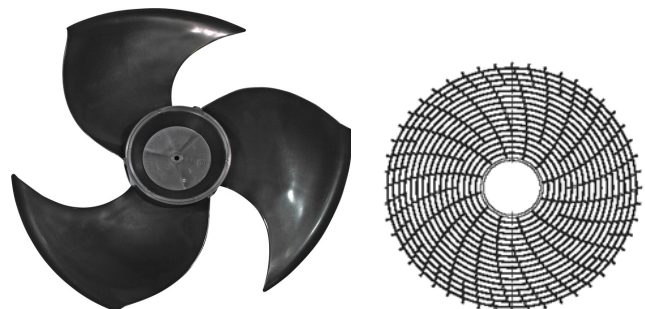

Advanced performance

The AquaSnap PLUS heat pump systems have an extremely high energy efficiency ratio in both cooling and heating mode, ensuring significant energy savings. Large, efficient coils and optimised circuiting ensure that all combinations meet the European tax rebate efficiency targets. Efficiency at part load conditions (seasonal energy efficiency) reaches the highest level in the industry.

Year-round comfort - the advanced technology used in the new AquaSnap PLUS heat pump condensing units provides optimised comfort levels for the end users, both in terms of water temperature control and quietness. The desired temperature is quickly reached and effectively maintained without fluctuations. The 30AW offers optimised individual comfort levels - both in winter and in summer.

Wide temperature operating range: AquaSnap PLUS heat pumps can operate efficiently in extreme temperature conditions. To suit the requirements of IT applications, the new AquaSnap PLUS can work at low-ambient conditions in cooling mode (down to 0°C and up to 46°C outside temperature). For end user comfort the units also operate down to -20°C outdoor temperature in heating mode, and in the summer season they produce hot water up to 60°C at up to 30°C outside temperature for domestic hot water applications.

Environmental care

Ozone-friendly R410A refrigerant.

Chlorine-free refrigerant of the HFC group with zero ozone depletion potential.

High-density refrigerant, therefore less refrigerant required.

Very efficient - gives an increased energy efficiency ratio (EER).

The components of AquaSnap PLUS heat pump systems are free of any hazardous substances.

The new packaging ensures high protection during transport and handling and is 100% recyclable.

Fast and simple installation and service

Easy access to all internal components: simply undo three screws to remove the complete front panel to access the refrigerant piping connections, control box and electrical connections, as well as the compressor and other key parts. Advanced circuit design and component selection has resulted in a compact unit with an exceptionally small footprint that is easy to transport even through narrow doors. Reduced operating weight and a handle on the unit panels to facilitate transport.

No additional buffer tank required, simplifying and speeding up the installation process.

3 bar pressure relief valve as standard.

Two or three-litre internal expansion tank.

High-temperature refrigerant protection.

Water flow switch to ensure that the circuits contain enough water to operate correctly.

Various power cable outlet options: pre-punched holes in the cabinet panels permit cable exit on the side, front or rear. Dealer service tool connection kit includes the software and connections to monitor the operating parameters from a personal computer, giving an easy-to-read display with visual graphs and statistics indicators.

All 30AW units are equipped with 1 inch gas MPT water connections.

Option for an integrated hydronic module reduces space requirements and simplifies the installation. Only the power and the water supply and return piping need to be connected.



Condensate drain piping connection to the unit includes a leak-proof pipe rubber joint.

Specially shaped anchorage feet ensure correct and safe unit fixing to the foundation.

The Comfort™ Series programmable thermostat periodically runs system checks to monitor and assess the unit operating parameters (standard parameters for the H version (AC) are 45°C LWT in heating and 7°C LWT in cooling, and for the X version (CHF) 35°C LWT in heating and 15°C LWT in cooling.). If a problem occurs, troubleshooting fault codes and messages help the service technician to identify the fault.

Detachable GMC board



DC inverter twin-rotary compressor

Advanced technology providing maximum energy-efficiency with high capacity available at peak conditions and optimised efficiency at low and mid compressor speeds. The AquaSnap PLUS heat pump DC inverter uses Intelligent Power Drive Unit (IPDU) hybrid inverter technology, combining two electronic management logics: Pulse Amplitude Modulation (PAM) and Pulse Width Modulation (PWM) for optimised compressor operation in all conditions, minimised temperature fluctuations, and providing perfect individual comfort control with significantly reduced energy consumption:

- PAM: pulse amplitude modulation of the direct current controls the compressor at maximum load conditions (start-up and peak load), increasing the voltage at fixed frequency. The compressor works at high speed to rapidly achieve the desired temperature.
- PWM: pulse width modulation of the direct current controls the compressor at partial load conditions, adjusting the frequency at fixed voltage. The compressor speed is fine-tuned and the system provides high-level comfort (no temperature fluctuations) at exceptionally efficient working conditions.

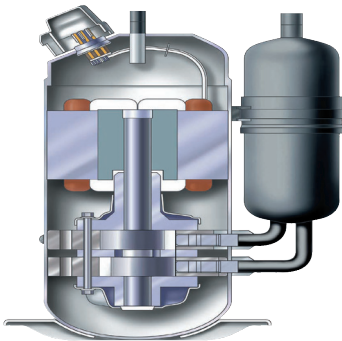

Compressor frequency is increased continuously up to the maximum level. This ensures that there are no current draw peaks in the start-up phase and safe connection to a single-phase power supply even in large-capacity systems. The maximum operating current of AquaSnap PLUS systems is below 72 A (systems up to 4 kW) and below 23 A for larger systems (12 kW). Inverter ramp-up speed makes soft starts unnecessary and ensures immediate maximum power. The two rotary compression cylinders, offset from each other by 180°, and the DC brushless motor with the shaft in perfect balance ensure reduced vibration and noise, even at very low operating speeds. This results in an extremely wide range between minimum and maximum capacity with continuous operation, guaranteeing that the system is always optimised and provides maximum comfort at exceptionally high efficiency levels.

Twin-rotary cylinders, low vibrations and low load to the shaft ensure highest compressor reliability and a long trouble-free operating life.

All DC brushless twin-rotary compressors are equipped with crankcase heaters as standard.

A double compressor shield for acoustic insulation further reduces noise levels.

Double compressor shield

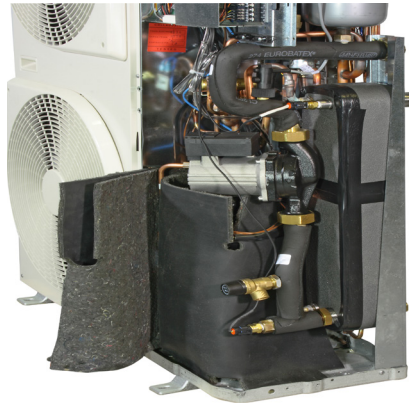

Superior reliability

Exceptional endurance tests

- Third-party testing and certification - all performances are certified by Eurovent and unit safety is certified by IMQ.
- All units are tested at various stages on the production line for circuit leakage, electrical compliance, water and refrigerant pressures.
- End-of-line test of all unit operating parameters.
- Corrosion resistance test.
- Accelerated ageing test on critical components and complete assembled units, simulating thousands of hours of continuous operation
- Packaging crash test to ensure that the units are adequately protected against accidental shocks.
- Extensive field and site testing.

Corrosion-resistant casing



Economical operation

Increased energy efficiency at part load

- The exceptionally high energy efficiency of the AquaSnap PLUS heat pumps is the result of a long qualification and optimisation process.
- Use of ambient air as primary source of energy in domestic heating applications significantly reduces the overall energy consumption and minimises CO₂ emissions.
- Night mode operation at reduced compressor speed, resulting in low-noise operation and a significant reduction in energy consumption.
- Easy-to-set and economical silent mode, reducing the compressor speed.
- R410A refrigerant is easier to use than other refrigerant blends.

GMC board

The new GMC controller was specifically developed for the AquaSnap PLUS inverter heat pumps, and incorporates new control algorithms. It features customised or pre-defined climate curves, domestic hot water control, a night-time noise reduction function, a defrost/alarm output signal, an external heat source, a pump block prevention function, freeze protection and compressor operation management.

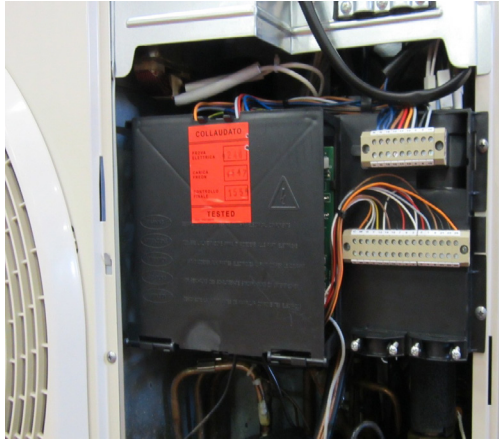

User interfaces

- The AquaSnap PLUS can use the following user interfaces:
- the 33AW-CS1 Comfort™ Series programmable thermostat with easy-to-read LCD screen. It provides enhanced control capability for maximised performance, reliability and indoor comfort and has extended programming features such as weekly scheduling and dehumidifier/humidifier signals. The sleek contemporary design blends in with any room decor.
 - the AquaSnap PLUS 33AW-RC1 remote controller
 - dry contacts



Comfort™ Series programmable thermostat 33AW-CS1



Remote controller 33AW-RC1

Type key

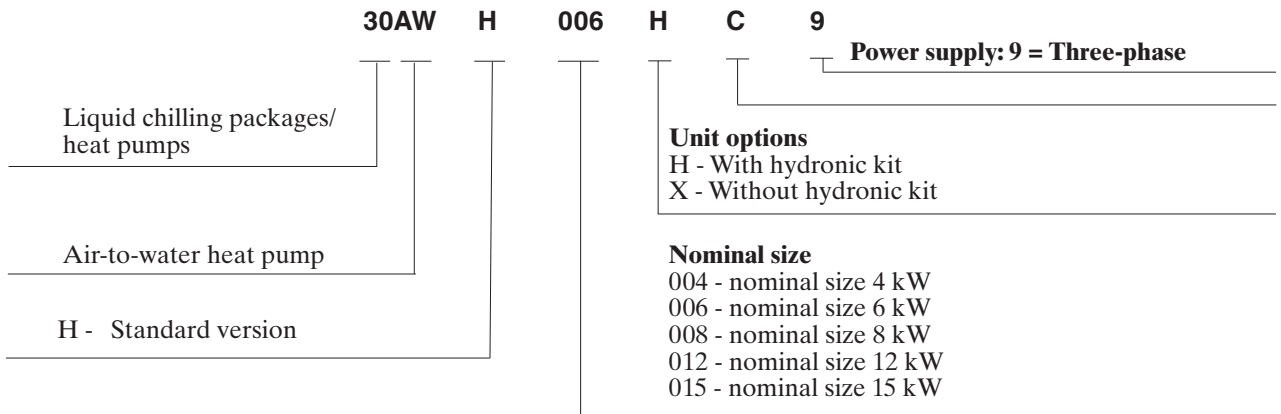

Options and accessories

Options	Description	Advantages	Use
Additional outdoor sensor	Additional outdoor sensor 33AW-RAS01	Better reading of outdoor air temperature	30AW 004-015
Remote controller	33AW-RC1 remote controller	On/off, heating/cooling and ECO mode	30AW 004-015
Programmable thermostat	33AW-CS1 Comfort™ series programmable thermostat	Extensive control features like weekly scheduling	30AW 004-015
80HMA comfort module	5 sizes with integrated system control, expansion vessel and electric booster heating or boiler backup	Complementary heating system	30AW 004-015
Domestic hot water tank 200 or 300 l, 1 coil	Domestic hot water tank 200 or 300 l	Storage, 200 l or 300 l of domestic hot water	30AW + 80HMA
Domestic hot water tank 200 or 300 l, 2 coils	Domestic hot water tank 200 or 300 l with thermal solar panel connection	Storage, 200 l or 300 l of domestic hot water	30AW + 80HMA

Note: All 30AWH sizes are compatible with 80HMA comfort module range and domestic hot water tank models.
Please refer to 80HMA documentation to get the option codes and the list of complementary accessories.
Please consider that 80HMA is necessary to manage water sensor and electric heater integrated into DHW tank.

Physical data

30AW		004	006	008	012	015	12-3Ph	15-3Ph
Data at Eurovent LCP/A/CHF conditions*								
Nominal heating capacity	kW	4.1	5.8	7.2	11.9	14.5	12.0	15.0
Power input	kW	0.98	1.35	1.80	3.01	3.54	2.79	3.57
COP	kW/kW	4.15	4.28	3.97	3.95	4.09	4.30	4.20
Eurovent class, heating		A	A	B	B	A	A	A
Nominal cooling capacity								
Nominal cooling capacity	kW	4.9	7.0	7.8	13.5	16.0	13.5	16.0
Power input	kW	1.17	1.90	1.96	3.70	4.17	3.25	4.20
EER	kW/kW	4.20	3.70	3.99	3.66	3.85	4.15	3.81
Eurovent class, cooling		A	B	A	B	A	A	A
Data at Eurovent LCP/A/AC conditions**								
Nominal heating capacity								
Nominal heating capacity	kW	3.9	5.8	7.4	12.9	14.0	11.2	14.5
Power input	kW	1.19	1.89	2.31	4.26	4.32	3.34	4.39
COP	kW/kW	3.26	3.05	3.19	3.03	3.23	3.35	3.30
Eurovent class, heating		A	B	B	B	A	A	A
Nominal cooling capacity								
Nominal cooling capacity	kW	3.3	4.7	5.8	10.2	13.0	10.2	13.0
Power input	kW	1.10	1.58	1.96	3.46	4.42	3.40	4.47
EER	kW/kW	3.02	3.00	2.98	2.96	2.95	3.00	2.91
ESEER part-load performance	kW/kW	4.4	4.5	4.2	4.2	4.3	4.4	4.3
Eurovent class, cooling		B	B	B	B	B	B	B
Nominal heating capacity, radiator applications***								
Nominal heating capacity	kW	4.1	5.4	6.5	11.5	11.7	5.0	12.0
Power input	kW	1.48	2.07	2.68	4.60	4.13	3.96	4.21
COP	kW/kW	2.75	2.60	2.41	2.49	2.82	2.80	2.85
Operating weight								
Operating weight	kg							
Unit without hydronic module		54	58	66	101	109	113	113
Unit with hydronic module		57	61	69	104	112	116	116
Refrigerant								
Refrigerant		R-410A	R-410A	R-410A	R-410A	R-410A	R-410A	R-410A
Compressor								
Compressor		DC twin-rotary						
Expansion valve		PMV	PMV	PMV	PMV	PMV	PMV	PMV
Hydronic circuit								
Net water volume	l	0.8	0.8	0.8	0.8	0.8	0.8	0.8
Expansion tank volume	l	2	2	2	3	3	3	3
Maximum water-side operating pressure	kPa	300	300	300	300	300	300	300
Water pressure drop, X version (CHF)	kPa	16	9.5	14.5	26	33	26	33
Available static pressure, H version (AC)	kPa	47	43	40	45	30	45	30
Water connections, inlet/outlet (MPT gas)	in	1	1	1	1	1	1	1
Fans								
Fans		Propeller fans						
Quantity/diameter	mm	1/495	1/495	1/495	2/495	2/495	2/495	2/495
Number of blades		3	3	3	3	3	3	3
Sound levels								
Sound power level, heating****	dB(A)	62	62	64	67	68	68	68
Sound power level, cooling†	dB(A)	64	64	65	68	69	69	69
Sound pressure level, heating****	dB(A)	42	42	44	47	48	48	48
Sound pressure level, cooling†	dB(A)	44	44	45	48	49	49	49

The water heat exchanger fouling factor is 0 (m² K)/W for all conditions.

* Standard Eurovent LCP/A/CHF conditions in heating mode: water heat exchanger entering/leaving water temperature 30 °C/35 °C, outside air temperature 7 °C db/6 °C wb. Standard Eurovent LCP/A/CHF conditions in cooling mode: water heat exchanger entering/leaving water temperature 23 °C/18 °C, outside air temperature 35 °C.

** Standard Eurovent LCP/A/AC conditions in heating mode: water heat exchanger entering/leaving water temperature 40 °C/45 °C, outside air temperature 7 °C db/6 °C wb. Standard Eurovent LCP/A/AC conditions in cooling mode: water heat exchanger entering/leaving water temperature 12 °C/7 °C, outside air temperature 35 °C.

*** Conditions in heating mode: entering/leaving water temperature 55 °C/a, outside air temperature 7 °C db/6 °C wb. Performances are in accordance with EN 14511.

**** Based on the following conditions: entering/leaving water temperature 35 °C/30 °C, outside air temperature 7 °C.

† Based on the following conditions: entering/leaving water temperature 12 °C/7 °C, outside air temperature 35 °C.

Note: The sound pressure level is measured in a hemispheric field at 4 m distance from the unit.

Electrical data

30AW		004	006	008	012	015	012-3Ph	015-3Ph
Power supply	V-ph-Hz	230-1-50	230-1-50	230-1-50	230-1-50	230-1-50	400-3-50	400-3-50
Voltage range	V	198-264	198-264	198-264	198-264	198-264	376-424	376-424
Full load current	A	7.2	11	14	23	20	16	16
Fuse rating	A	10	16	16	25	25	20	20
Main power cable section	mm ²	2.5	2.5	2.5	2.5	2.5	2.5	2.5

Sound power levels Lw

Cooling mode										
30AW		Octave bands, Hz							Sound power levels	
		125	250	500	1000	2000	4000	8000		
004	dB	61	68	62	56	51	47	41	dB(A)	64
006	dB	61	68	63	56	53	50	46	dB(A)	64
008	dB	66	62	63	59	56	55	51	dB(A)	65
012	dB	70	65	67	62	58	57	50	dB(A)	68
015	dB	70	68	66	64	61	58	53	dB(A)	69
012-3Ph	dB	70	68	66	64	61	58	53	dB(A)	69
015-3Ph	dB	70	68	66	64	61	58	53	dB(A)	69

Heating mode										
30AW		Octave bands, Hz							Sound power levels	
		125	250	500	1000	2000	4000	8000		
004	dB	67	62	61	56	50	47	43	dB(A)	62
006	dB	62	64	62	55	50	48	43	dB(A)	62
008	dB	66	65	63	57	54	52	45	dB(A)	64
012	dB	70	66	66	61	57	54	46	dB(A)	67
015	dB	72	68	67	63	59	56	50	dB(A)	68
012-3Ph	dB	72	68	67	63	59	56	50	dB(A)	68
015-3Ph	dB	72	68	67	63	59	56	50	dB(A)	68

Operating limits

	Cooling mode	Heating mode
Maximum outside temperature	46 °C	30 °C
Maximum leaving water temperature	18 °C	60 °C
Minimum outside temperature	0 °C (30AWH 004 + 006: 5°C)	-20 °C
Minimum leaving water temperature	4 °C	20 °C

Operating range, heating mode

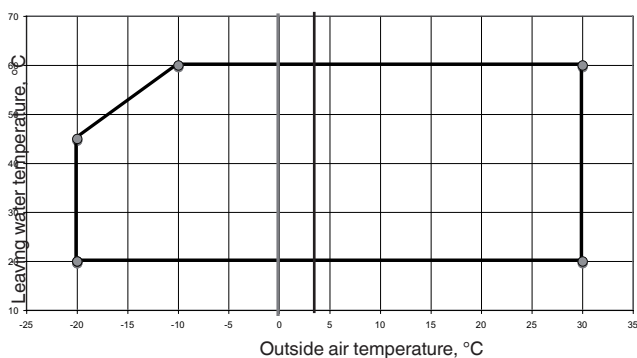

Operating range, cooling mode

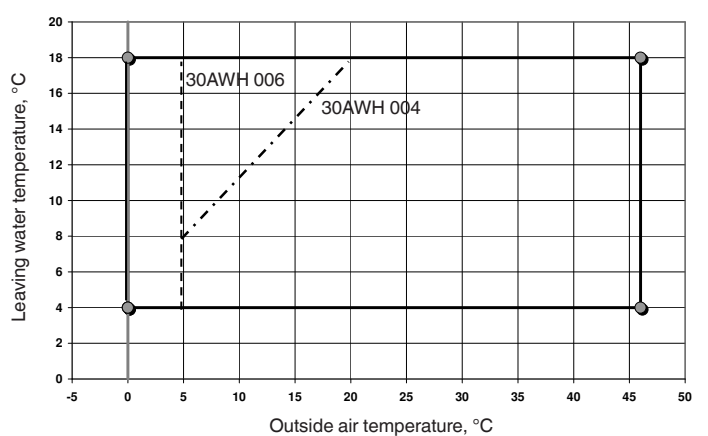

Available static pressure (units with hydronic module)

30AWH 004H

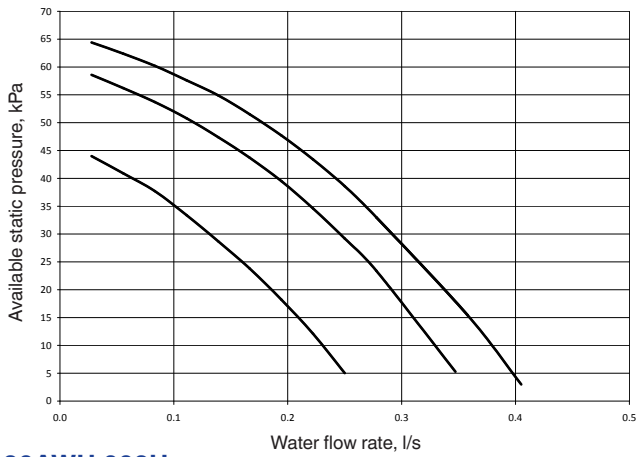

30AWH 006H

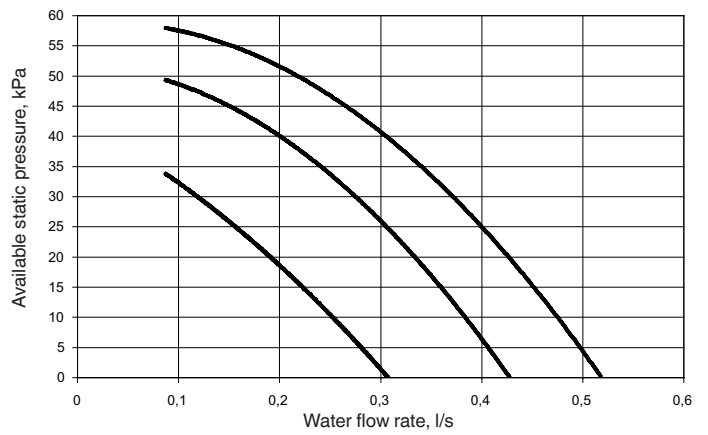

30AWH 008H

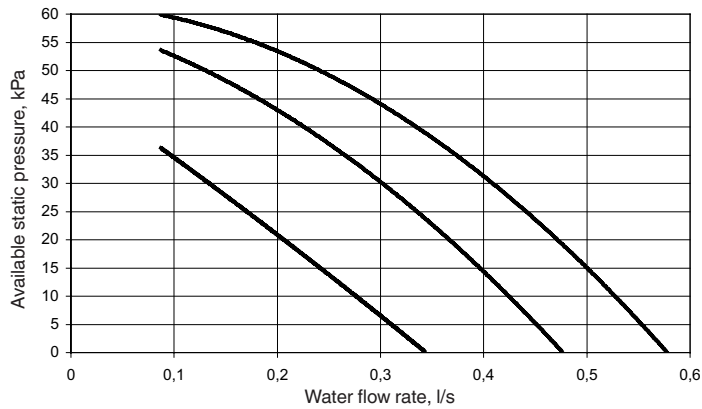

30AWH 012H + 015H

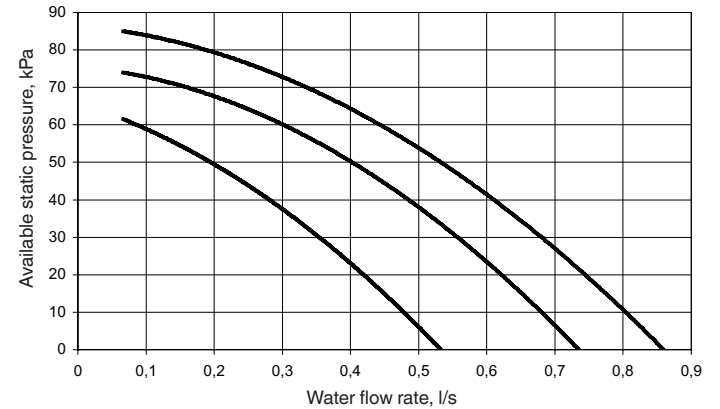

Pressure drop curves (units without hydronic module)

30AWH 004X

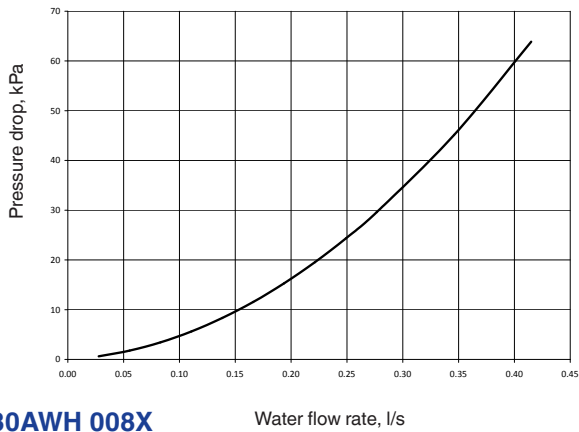

30AWH 006X

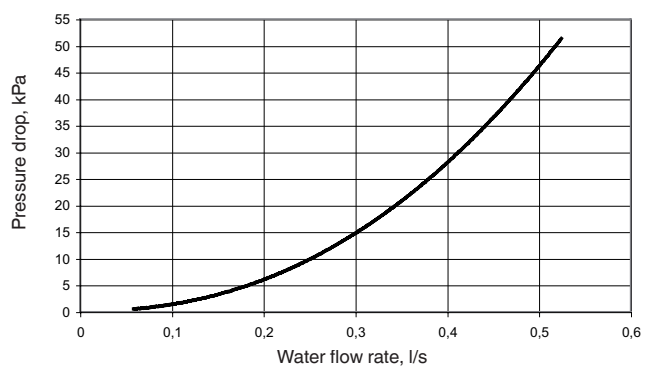

30AWH 008X

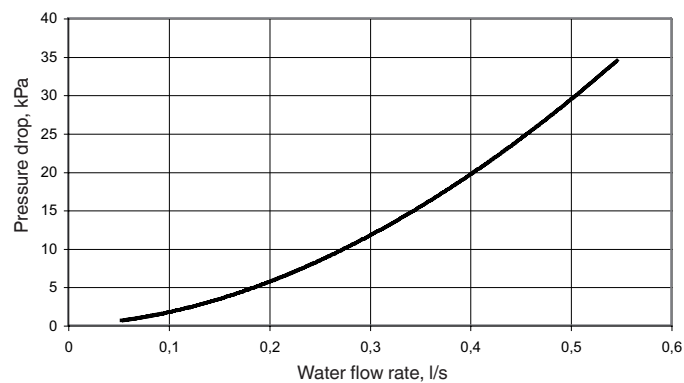

30AWH 012X + 015X

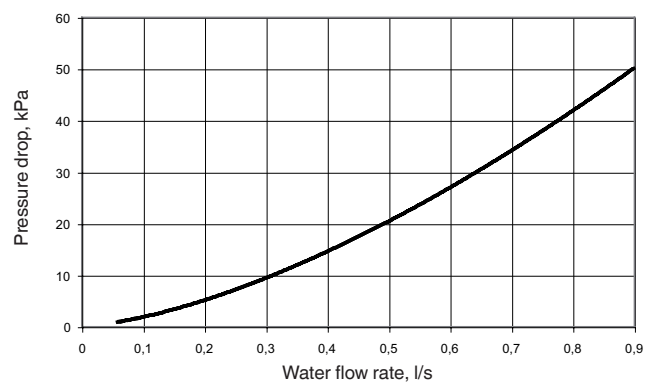

Dimensions, mm

30AW 004-008

30AW 012-015

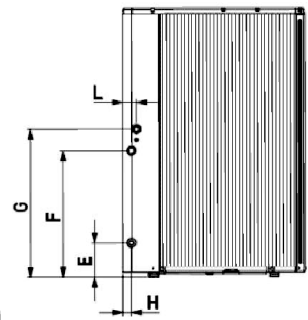
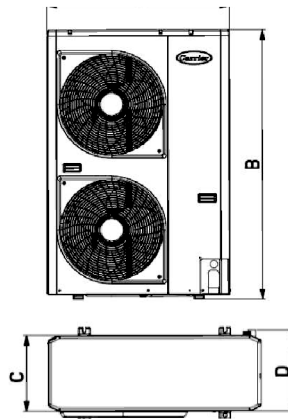
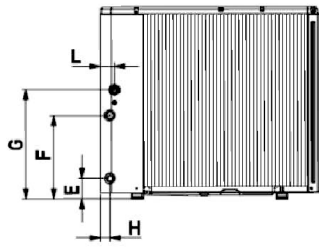
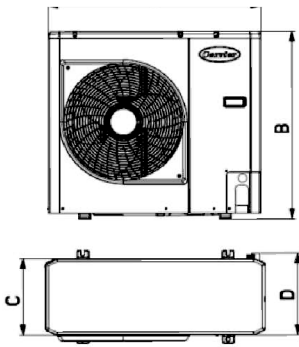

30AW	A	B	C	D	E	F	G	H	L
004	908	821	326	350	87	356	466	40	60
006	908	821	326	350	87	356	466	40	60
008	908	821	326	350	87	356	466	40	60
012	908	1363	326	350	174	640	750	44	69
015	908	1363	326	350	174	640	750	44	69

Clearances, mm

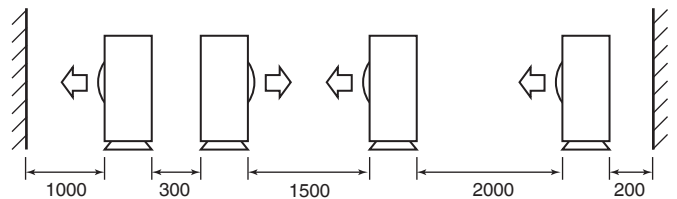
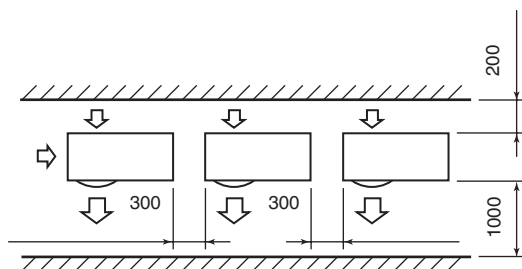
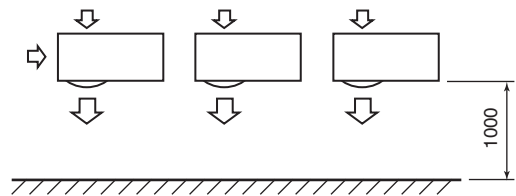
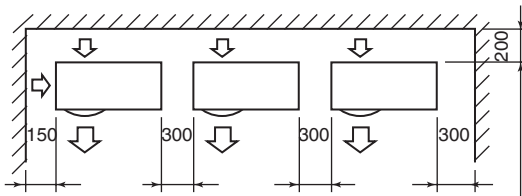
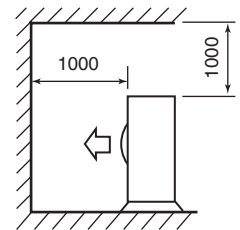
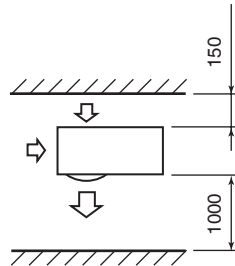
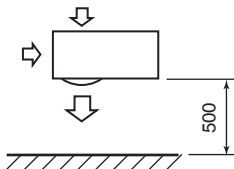
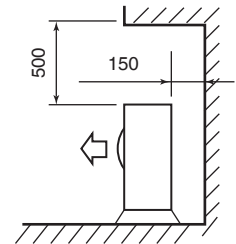
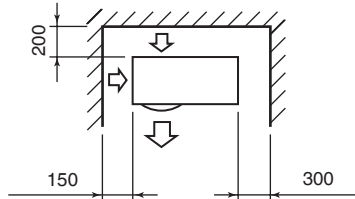
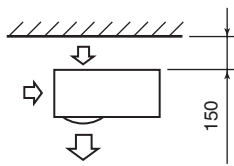

Heating capacities in accordance with EN14511-3:2011

30AWH units

LWT °C		Outside air dry-bulb (wet-bulb) temperature, °C																				
		-20 (-21)							-15 (-16)							-7 (-8)						
		Qh			COP			q	Qh			COP			q	Qh			COP			q
kW			kW/kW			l/s	kW			kW/kW			l/s	kW			kW/kW			l/s		
Nom Min Max			Nom Min Max			Nom	Nom Min Max			Nom Min Max			Nom	Nom Min Max			Nom Min Max			Nom		
30AWH004H--	35	1.22	0.45	1.22	1.16	1.80	1.16	0.058	2.35	0.49	2.67	2.00	2.20	1.90	0.112	2.50	0.52	2.80	2.40	2.55	2.30	0.119
		3.00	0.45	3.11	2.06	2.10	2.00	0.143	3.20	0.60	3.26	2.31	2.47	2.21	0.153	3.44	0.64	3.50	2.51	2.69	2.40	0.164
		1.76	0.56	1.76	2.46	2.50	2.46	0.084	3.20	0.73	3.70	2.47	2.64	2.00	0.153	3.76	0.78	4.20	2.63	2.81	2.10	0.180
		3.22	1.50	3.22	2.08	2.10	2.08	0.154	6.44	1.95	7.28	2.28	2.31	2.26	0.308	6.94	2.10	7.40	2.52	2.56	2.50	0.332
		4.45	1.26	4.45	1.78	1.84	1.78	0.213	7.42	1.63	8.30	2.36	2.42	2.33	0.355	7.80	1.76	9.10	2.50	2.57	2.47	0.382
		4.01	1.34	4.01	1.95	1.90	1.95	0.143	6.68	1.74	7.52	2.51	2.65	2.51	0.286	7.12	1.88	8.73	2.66	2.74	2.50	0.340
		4.45	1.36	4.45	1.78	1.88	1.78	0.177	7.42	1.76	8.35	2.45	2.47	2.45	0.355	8.00	1.90	9.46	2.60	2.62	2.40	0.382
30AWH004H--	45	1.18	0.40	1.18	1.07	1.75	1.07	0.056	2.28	0.44	2.56	1.85	2.10	1.80	0.109	2.40	0.49	2.60	2.15	2.38	2.00	0.115
		1.44	0.44	1.44	1.82	2.02	1.82	0.069	3.20	0.59	3.24	2.13	2.31	2.03	0.153	3.45	0.64	3.50	2.20	2.39	2.11	0.165
		1.27	0.57	1.27	2.00	1.96	2.00	0.061	3.35	0.71	3.60	2.11	2.26	1.65	0.160	3.85	0.76	4.00	2.23	2.45	1.70	0.184
		3.02	1.23	3.02	1.96	2.00	1.96	0.144	6.04	1.83	6.82	2.10	2.14	2.08	0.288	6.63	2.01	7.50	2.19	2.23	2.17	0.317
		3.00	1.28	3.00	1.70	1.73	1.70	0.143	7.05	1.55	7.98	2.08	2.14	2.06	0.358	7.65	1.76	9.10	2.20	2.26	2.17	0.382
		3.00	1.39	3.00	1.72	1.74	1.72	0.133	6.35	1.75	7.23	1.82	2.16	1.82	0.140	5.87	1.77	8.72	2.26	2.28	2.20	0.281
		3.00	1.38	3.00	1.70	1.73	1.70	0.133	7.05	1.62	8.03	1.80	2.14	1.80	0.191	8.00	1.76	9.44	2.26	2.26	2.13	0.382
30AWH004H--	55	0.35	0.35	0.35	1.50	1.50	1.50	0.017	1.17	0.40	1.17	1.60	1.80	1.60	0.056	2.44	0.44	2.49	1.78	1.91	1.77	0.117
		0.43	0.43	0.43	1.64	1.64	1.64	0.021	1.58	0.56	1.58	1.76	1.95	1.76	0.075	3.28	0.61	3.33	1.90	2.06	1.85	0.157
		0.49	0.49	0.49	1.80	1.80	1.80	0.023	0.83	0.69	0.83	1.88	1.98	1.88	0.039	3.60	0.74	3.96	1.86	2.09	1.65	0.172
		1.13	1.13	1.13	1.53	1.53	1.53	0.054	2.87	1.69	2.87	1.67	1.69	1.67	0.137	6.37	1.93	7.20	1.80	1.83	1.78	0.304
		1.26	1.26	1.26	1.62	1.62	1.62	0.06	3.00	1.53	3.00	1.74	1.80	1.74	0.143	7.35	1.65	7.94	1.85	1.90	1.74	0.358
		1.28	1.28	1.28	1.70	1.70	1.70	0.061	2.89	1.71	2.89	1.73	1.82	1.73	0.111	5.79	1.67	6.97	1.86	1.92	1.84	0.277
		1.27	1.27	1.27	1.69	1.69	1.69	0.057	3.00	1.59	3.00	1.78	1.80	1.78	0.124	6.49	1.65	7.94	1.88	1.90	1.76	0.31
30AWH004H--	60	0.32	0.32	0.32	1.38	1.38	1.38	0.015	0.36	0.36	0.36	1.58	1.58	1.58	0.017	2.23	0.40	2.45	1.75	1.87	1.72	0.107
		0.39	0.39	0.39	1.53	1.53	1.53	0.019	0.52	0.52	0.52	1.71	1.71	1.71	0.025	3.01	0.56	3.06	1.69	1.80	1.62	0.144
		0.40	0.40	0.40	1.41	1.41	1.41	0.019	0.59	0.59	0.59	1.50	1.50	1.50	0.028	1.83	0.65	2.22	1.57	1.58	1.55	0.087
		1.10	1.10	1.10	1.35	1.35	1.35	0.052	1.48	1.48	1.48	1.49	1.49	1.49	0.084	6.12	1.85	6.92	1.56	1.59	1.55	0.293
		1.22	1.22	1.22	1.49	1.49	1.49	0.058	1.49	1.49	1.49	1.60	1.60	1.60	0.071	6.57	1.51	7.57	1.64	1.67	1.61	0.314
		1.23	1.23	1.23	1.42	1.42	1.42	0.057	1.50	1.50	1.50	1.52	1.52	1.52	0.07	5.41	1.53	6.73	1.56	1.57	1.52	0.258
		1.22	1.12	1.22	1.34	1.34	1.34	0.054	1.49	1.49	1.49	1.48	1.48	1.48	0.069	6.66	1.51	7.54	1.51	1.55	1.42	0.318

LWT °C		Outside air dry-bulb (wet-bulb) temperature, °C																				
		-3(-4)							0 (-1)							2 (1)						
		Qh			COP			q	Qh			COP			q	Qh			COP			q
kW			kW/kW			l/s	kW			kW/kW			l/s	kW			kW/kW			l/s		
Nom Min Max			Nom Min Max			Nom	Nom Min Max			Nom Min Max			Nom	Nom Min Max			Nom Min Max			Nom		
30AWH004H--	35	2.80	0.57	3.13	2.60	2.82	2.80	0.134	2.90	0.61	3.33	2.90	3.02	3.00	0.139	3.25	0.64	3.60	3.00	3.12	3.15	0.155
		3.75	0.70	3.82	2.77	2.97	2.65	0.179	3.99	0.74	4.06	2.97	3.18	2.84	0.191	4.20	0.78	4.27	3.07	3.29	2.94	0.201
		4.36	0.88	4.83	2.81	3.04	2.38	0.208	4.74	0.96	5.24	2.94	3.21	2.54	0.226	5.12	1.01	5.52	2.99	3.27	2.64	0.245
		7.83	2.37	8.85	2.85	2.90	2.83	0.374	8.50	2.57	9.61	3.00	3.05	2.97	0.406	8.75	2.87	10.11	3.11	3.16	3.08	0.418
		8.98	1.97	10.21	2.81	2.88	2.78	0.429	8.99	2.13	11.05	3.04	3.12	3.00	0.464	9.50	2.45	12.07	3.10	3.28	3.16	0.487
		7.68	2.11	9.51	2.82	2.97	2.72	0.367	7.85	2.28	9.92	2.84	3.11	2.74	0.375	8.55	2.62	11.02	3.17	3.28	3.08	0.409
		8.49	2.13	10.54	2.75	2.94	2.69	0.406	8.69	2.30	11.15	2.77	3.08	2.70	0.415	9.50	2.65	12.55	3.10	3.24	3.07	0.454
30AWH004H--	45	2.70	0.52	3.03	2.40	2.55	2.36	0.129	2.80	0.55	3.23	2.52	2.68	2.50	0.134	3.00	0.60	3.40	2.64	2.87	2.60	0.143
		3.76	0.69	3.80	2.31	2.51	2.21	0.180	4.00	0.72	4.02	2.39	2.59	2.29	0.191	4.20	0.79	4.22	2.51	2.78	2.40	0.201
		4.45	0.87	4.78	2.34	2.51	1.85	0.212	4.81	0.95	5.20	2.42	2.55	2.01	0.230	5.15	0.99	5.48	2.55	2.69	2.11	0.246
		7.43	2.25	8.40	2.31	2.34	2.29	0.355	8.06	2.44	9.12	2.42	2.46	2.40	0.385	8.48	2.74	9.59	2.61	2.67	2.57	0.405
		8.98	1.97	10.21	2.34	2.40	2.31	0.429	9.71	2.13	11.05	2.44	2.51	2.42	0.464	9.50	2.47	11.43	2.60	2.71	2.56	0.487
		6.23	1.99	9.44	2.39	2.43	2.33	0.298	6.68	2.15	9.83	2.49	2.53	2.43	0.319	7.50	2.49	10.59	2.70	2.74	2.58	0.358
		8.40	1.97	10.48	2.39	2.40	2.27	0.401	8.61	2.13	11.04	2.49	2.51	2.37	0.412	9.30	2.47	11.88	2.65	2.71	2.51	0.444
30AWH004H--	55	2.77	0.48	2.83	1.92	2.04	1.89	0.132	2.99	0.50	3.05	2.01	2.14	1.98	0.143	3.15	0.56	3.21	2.13	2.27	2.11	0.15
		3.70	0.67	3.75	2.04	2.20	1.97	0.177	3.97	0.70	4.00	2.14	2.31	2.07	0.19	4.19	0.78	4.19	2.26	2.44	2.20	0.2
		4.23	0.84	4.59	1.97	2.19	1.76	0.202	4.50	0.91	4.98	2.08	2.35	1.85	0.215	4.86	0.96	5.24	2.20	2.40	2.00	0.232
		7.44	2.25	8.41	1.98	2.01	1.96	0.355	8.23	2.45	9.13	2.08	2.11	2.06	0.393	8.66	2.71	9.61	2.20	2.23	2.18	0.414
		7.99	1.86	8.43	1.98	2.03	1.86	0.382	8.26	2.02	8.73	2.08	2.13	1.95	0.395	8.97	2.30	9.47	2.20	2.25	2.06	0.428
		6.35	1.88	7.50	2.00	2.05	1.97	0.304	6.39	2.04	8.02	2.10	2.15	2.06	0.305	7.49	2.33	8.70	2.28	2.28	2.18	0.358
		6.90	1.86	8.71	2.01	2.03	1.88	0.33	7.56	2.02	8.95	2.11	2.13	1.97	0.361	7.96	2.30	10.18	2.24	2.25	2.08	0.38
30AWH004H--	60	2.56	0.44	2.80	1.90	2.00	1.85	0.122	2.76	0.46	3.01	1.95	2.09	1.93	0.132	2.91	0.52	3.18	2.08	2.21	2.06	0.139
		3.39	0.63	3.48	1.80	1.93	1.73	0.162	3.68	0.68	3.80	1.89	2.02	1.82	0.176	3.87	0.72	4.01	1.99	2.13	1.92	0.185
		2.06	0.73	2.51	1.68	1.69	1.66	0.098	2.24	0.79	2.72	1.76	1.78	1.74	0.107	2.35	0.84	2.86	1.86	1.88	1.85	0.112
		6.91	2.09	7.81	1.67	1.70	1.66	0.33	7.49	2.27	8.47	1.75	1.78	1.74	0.358	7.89	2.50	8.92	1.85	1.88	1.83	0.377
		6.75	1.71	7.86	1.76	1.79	1.74	0.323	7.04	1.85	8.21	1.85	1.87	1.82	0.336	7.41	2.10	9.04	1.95	1.98	1.92	0.354
		5.93	1.72	7.38	1.56	1.59	1.54	0.283	5.97	1.87	7.58	1.60	1.63	1.58	0.285	7.08	2.12	8.62	2.04	2.06	2.00	0.338
		7.30	1.71	8.27	1.52	1.57	1.46	0.349	7.50	1.85	8.50	1.56	1.61	1.53	0.358	8.53	2.10	9.67	1.98	2.04	1.93	0.408

Heating capacities in accordance with EN14511-3:2011

30AWH units

		Outside air dry-bulb (wet-bulb) temperature, °C																				
		7 (6)							10 (9)							20 (19)						
		Qh			COP			q	Qh			COP			q	Qh			COP			q
LWT °C		kW			kW/kW			l/s	kW			kW/kW			l/s	kW			kW/kW			l/s
		Nom	Min	Max	Nom	Min	Max	Nom	Nom	Min	Max	Nom	Min	Max	Nom	Nom	Min	Max	Nom	Min	Max	Nom
35	30AWH004H--	4.10	0.77	4.73	4.05	4.10	3.97	0.196	4.45	0.83	5.14	4.47	4.50	4.38	0.213	5.62	1.05	6.49	5.45	5.59	5.20	0.269
	30AWH006H--	5.80	1.08	6.14	4.20	4.49	3.97	0.277	6.32	1.18	6.67	4.63	4.96	4.38	0.302	7.98	1.49	8.42	6.07	6.49	5.73	0.381
	30AWH008H--	7.20	1.34	8.00	3.91	4.17	3.44	0.344	7.82	1.46	8.69	4.26	4.56	3.76	0.373	9.87	1.84	10.97	5.46	5.84	4.81	0.472
	30AWH012H--	11.90	3.61	13.45	3.91	3.96	3.86	0.569	12.92	3.91	14.61	4.30	4.37	4.26	0.617	16.32	4.94	18.45	5.63	5.72	5.58	0.780
	30AWH015H--	14.46	3.18	16.25	4.09	4.17	4.01	0.693	15.74	3.46	17.47	4.48	4.59	4.42	0.752	19.89	4.37	21.65	5.87	6.02	5.80	0.950
	30AWH012H--9	12.00	3.40	15.00	4.30	4.39	4.20	0.573	12.86	3.70	16.13	4.68	4.73	4.57	0.614	16.14	4.67	20.24	6.03	6.20	5.89	0.771
	30AWH015H--9	15.00	3.44	17.41	4.20	4.25	4.18	0.717	16.13	3.73	18.73	4.57	4.69	4.55	0.771	20.24	4.72	23.49	5.89	6.14	5.86	0.967
45	30AWH004H--	3.90	0.70	4.50	3.20	3.40	3.15	0.186	4.19	0.78	4.84	3.39	3.60	3.33	0.200	5.17	1.00	5.97	4.02	4.27	3.95	0.247
	30AWH006H--	5.80	1.06	6.04	3.01	3.24	2.91	0.277	6.24	1.14	6.49	3.18	3.43	3.08	0.298	7.70	1.41	8.20	3.77	4.07	3.66	0.368
	30AWH008H--	7.40	1.32	7.92	3.16	3.45	2.84	0.354	8.03	1.44	8.57	3.44	3.74	3.08	0.384	10.02	1.82	10.75	4.34	4.73	3.89	0.479
	30AWH012H--	11.45	3.47	12.95	3.03	3.08	3.01	0.547	12.31	3.73	13.92	3.21	3.26	3.18	0.588	15.18	4.60	17.16	3.80	3.86	3.77	0.725
	30AWH015H--	13.96	3.07	15.92	3.23	3.29	3.17	0.669	15.05	3.30	17.12	3.40	3.49	3.36	0.719	18.55	4.07	20.35	4.03	4.14	3.99	0.886
	30AWH012H--9	11.20	3.10	14.50	3.35	3.33	3.30	0.535	11.97	3.34	15.90	3.40	3.52	3.40	0.572	15.03	4.11	18.92	3.85	4.18	4.03	0.718
	30AWH015H--9	14.50	3.07	16.52	3.30	3.29	3.21	0.693	15.90	3.30	18.11	3.40	3.49	3.31	0.760	18.92	4.07	21.55	4.03	4.14	3.92	0.904
55	30AWH004H--	4.10	0.65	4.22	2.71	2.75	2.60	0.196	4.41	0.72	4.52	2.90	2.95	2.84	0.211	5.41	0.95	5.55	3.44	3.50	3.39	0.258
	30AWH006H--	5.40	1.02	5.58	2.58	2.78	2.53	0.258	5.98	1.10	6.10	2.72	2.93	2.70	0.286	6.87	1.35	7.05	3.23	3.43	3.18	0.328
	30AWH008H--	6.70	1.25	7.46	2.30	2.50	2.12	0.32	7.25	1.35	8.05	2.87	3.07	2.68	0.346	9.05	1.68	10.05	3.49	3.73	3.20	0.432
	30AWH012H--	10.27	3.36	11.50	2.50	2.54	2.48	0.49	11.46	3.61	12.35	2.63	2.68	2.63	0.547	13.85	4.42	14.60	3.08	3.13	3.08	0.662
	30AWH015H--	11.66	2.78	12.35	2.82	2.87	2.63	0.575	12.70	2.98	13.41	2.97	3.04	2.78	0.607	15.02	3.66	15.76	3.52	3.61	3.31	0.718
	30AWH012H--9	11.05	2.81	13.09	2.80	2.90	2.78	0.528	11.88	3.01	14.32	3.02	3.07	2.95	0.568	14.91	3.69	17.13	3.56	3.64	3.50	0.712
	30AWH015H--9	12.00	2.78	15.26	2.85	2.87	2.65	0.573	13.07	2.98	16.81	3.02	3.04	2.80	0.624	15.68	3.66	20.02	3.58	3.61	3.33	0.749
60	30AWH004H--	3.83	0.61	4.18	2.48	2.70	2.45	0.183	4.07	0.68	4.44	2.61	2.90	2.58	0.195	4.94	0.91	5.44	3.07	3.45	3.04	0.236
	30AWH006H--	5.00	0.93	5.07	2.25	2.41	2.23	0.239	5.32	0.99	5.32	2.37	2.53	2.37	0.254	6.07	1.19	6.07	2.79	2.96	2.79	0.29
	30AWH008H--	3.04	1.08	3.70	2.12	2.14	2.10	0.145	3.25	1.15	3.95	2.26	2.28	2.24	0.155	3.95	1.41	4.81	2.71	2.74	2.69	0.189
	30AWH012H--	10.19	3.09	11.00	2.09	2.12	2.08	0.487	10.84	3.28	11.25	2.20	2.23	2.20	0.518	11.10	3.95	11.60	2.56	2.60	2.56	0.53
	30AWH015H--	10.03	2.52	11.24	2.20	2.23	2.10	0.479	11.25	2.59	11.25	2.30	2.33	2.30	0.537	11.90	3.12	11.90	2.48	2.72	2.48	0.568
	30AWH012H--9	10.65	2.54	12.93	2.69	2.70	2.63	0.509	11.58	2.62	13.83	2.81	2.87	2.78	0.553	14.21	3.15	16.36	3.37	3.42	3.32	0.679
	30AWH015H--9	12.80	2.52	14.50	2.60	2.68	2.54	0.612	13.69	2.59	15.97	2.75	2.84	2.69	0.654	16.03	3.12	19.02	3.29	3.39	3.21	0.766

Legend

LWT - Leaving Water Temperature, °C
 Qh - Heating Capacity, kW
 Nom - Nominal
 Min - Minimum
 Max - Maximum
 COP - Coefficient of Performance
 q - Condenser water flow rate, l/s

Application Data

Standard units, refrigerant: R-410A
 Condenser entering/leaving water temperature difference: 5 K
 Condenser fluid: water
 Fouling Factor: 0.0 m² K/W

Performance in accordance with EN 14511-3: 2011

Cooling capacities in accordance with EN14511-3:2011

38AWH units

LWT °C		Outside air Temperature, °C																				
		5						15						25								
		Qc kW		EER kW/kW			q l/s	Qc kW		EER kW/kW			q l/s	Qc kW		EER kW/kW			q l/s			
Nom	Min	Max	Nom	Min	Max	Nom	Nom	Min	Max	Nom	Min	Max	Nom	Min	Max	Nom	Min	Max	Nom			
5	30AWH004H--	1.29	1.17	1.29	8.31	9.24	8.31	0.062	1.16	1.05	1.16	7.21	8.01	7.21	0.055	3.50	0.93	3.50	3.55	5.99	3.55	0.167
	30AWH006H--	1.14	1.04	1.14	9.36	10.40	9.36	0.054	1.00	0.91	1.00	8.22	9.13	8.22	0.048	5.16	0.79	5.16	3.66	7.45	3.66	0.247
	30AWH008H--	6.16	0.57	7.31	8.68	9.67	8.12	0.294	5.60	0.52	6.66	5.71	6.95	5.53	0.268	5.05	0.47	6.00	3.97	4.75	3.85	0.241
	30AWH012H--	14.66	4.62	16.97	5.94	8.65	4.81	0.701	11.83	4.26	13.36	4.94	5.82	4.49	0.565	10.81	3.89	12.21	3.69	4.25	3.41	0.516
	30AWH015H--	19.14	4.54	20.01	5.13	8.94	4.75	0.914	15.33	4.18	15.70	4.69	6.01	4.69	0.732	14.01	3.82	14.34	3.58	4.42	3.56	0.669
	30AWH012H--9	13.79	4.45	19.71	5.96	8.76	4.42	0.659	11.37	4.10	15.86	5.19	5.89	4.59	0.543	10.41	3.74	14.49	3.72	4.33	3.48	0.497
	30AWH015H--9	19.14	4.54	20.01	5.13	8.94	4.75	0.914	15.33	4.18	15.70	4.69	6.01	4.69	0.732	14.01	3.82	14.34	3.58	4.42	3.56	0.669
7	30AWH004H--	1.43	1.30	1.43	9.20	10.22	9.20	0.068	1.28	1.16	1.28	7.90	8.78	7.90	0.061	3.82	1.03	3.82	3.88	6.55	3.88	0.182
	30AWH006H--	1.26	1.15	1.26	10.14	11.27	10.14	0.06	1.11	1.01	1.11	8.91	9.90	8.91	0.053	5.61	0.88	5.61	3.88	7.93	3.88	0.268
	30AWH008H--	6.86	0.69	7.95	9.01	10.78	8.47	0.328	6.25	0.63	7.24	6.10	7.80	5.89	0.299	5.63	0.56	6.53	4.23	5.40	4.08	0.269
	30AWH012H--	13.62	5.12	15.57	7.64	9.94	6.69	0.651	12.57	4.72	14.37	5.24	6.81	4.59	0.6	11.47	4.31	13.12	3.88	4.74	3.51	0.548
	30AWH015H--	17.37	5.02	18.11	7.43	10.65	7.10	0.83	16.01	4.62	16.69	5.09	7.30	4.87	0.765	14.62	4.22	15.24	3.85	5.07	3.72	0.698
	30AWH012H--9	12.82	4.92	17.83	8.07	10.44	6.76	0.613	12.12	4.53	16.86	5.69	7.15	4.77	0.579	11.14	4.14	15.39	4.03	4.97	3.65	0.532
	30AWH015H--9	17.37	5.02	18.11	7.43	10.65	7.10	0.83	16.01	4.62	16.69	5.09	7.30	4.87	0.765	14.62	4.22	15.24	3.85	5.07	3.72	0.698
10	30AWH004H--	1.63	1.48	1.63	10.52	11.69	10.52	0.078	1.47	1.33	1.47	8.94	9.93	8.94	0.07	4.29	1.19	4.29	4.36	7.39	4.36	0.205
	30AWH006H--	1.44	1.31	1.44	11.32	12.57	11.32	0.069	1.28	1.16	1.28	9.95	11.05	9.95	0.061	6.29	1.01	6.29	4.19	8.65	4.19	0.3
	30AWH008H--	7.92	0.86	8.91	9.52	12.45	8.99	0.378	7.22	0.78	8.12	6.68	9.07	6.43	0.345	6.51	0.71	7.33	4.61	6.39	4.44	0.311
	30AWH012H--	12.05	5.86	13.47	10.21	11.87	9.51	0.576	13.67	5.41	15.89	5.69	8.29	4.73	0.653	12.46	4.94	14.48	4.17	5.48	3.65	0.596
	30AWH015H--	14.72	5.73	15.25	10.87	13.22	10.64	0.703	17.04	5.29	18.19	5.69	9.24	5.14	0.814	15.54	4.82	16.58	4.25	6.05	3.97	0.742
	30AWH012H--9	11.37	5.62	15.01	11.23	12.95	10.28	0.543	13.25	5.18	18.36	6.44	9.05	5.03	0.633	12.23	4.73	16.74	4.50	5.93	3.89	0.584
	30AWH015H--9	14.72	5.73	15.25	10.87	13.22	10.64	0.703	17.04	5.29	18.18	5.69	9.24	5.14	0.814	15.54	4.82	16.58	4.25	6.05	3.97	0.742
15	30AWH004H--	1.79	1.79	1.79	14.13	14.13	14.13	0.085	1.78	1.61	1.78	10.66	11.85	10.66	0.085	5.09	1.44	5.09	5.17	8.79	5.17	0.243
	30AWH006H--	1.59	1.59	1.59	14.75	14.75	14.75	0.076	1.56	1.42	1.56	11.68	12.97	11.68	0.074	7.41	1.24	7.41	4.72	9.86	4.72	0.354
	30AWH008H--	9.68	1.14	10.51	10.35	15.23	9.85	0.462	8.83	1.04	9.59	7.66	11.19	7.33	0.422	7.98	0.94	8.66	5.24	8.04	5.02	0.381
	30AWH012H--	7.11	7.11	7.11	15.10	15.10	15.10	0.34	15.52	6.57	18.41	6.44	10.75	4.98	0.741	14.12	5.98	16.76	4.66	6.70	3.90	0.675
	30AWH015H--	6.93	6.93	6.93	17.50	17.50	17.50	0.331	18.75	6.40	20.67	6.70	12.47	5.59	0.896	17.06	5.83	18.82	4.93	7.69	4.38	0.815
	30AWH012H--9	6.79	6.79	6.79	17.15	17.15	17.15	0.324	15.14	6.27	20.87	7.68	12.22	5.47	0.723	14.05	5.71	19.00	5.28	7.53	4.29	0.671
	30AWH015H--9	6.93	6.93	6.93	17.50	17.50	17.50	0.331	18.75	6.40	20.67	6.70	12.47	5.59	0.896	17.06	5.83	18.82	4.93	7.69	4.38	0.815
18	30AWH004H--	1.97	1.97	1.97	15.60	15.60	15.60	0.094	1.96	1.78	1.96	11.70	13.00	11.70	0.094	5.56	1.59	5.56	5.65	9.62	5.65	0.266
	30AWH006H--	1.75	1.75	1.75	16.06	16.06	16.06	0.084	1.72	1.57	1.72	12.71	14.13	12.71	0.082	8.08	1.38	8.08	5.04	10.58	5.04	0.386
	30AWH008H--	10.73	1.31	11.46	10.86	16.89	10.37	0.513	9.80	1.20	10.47	8.24	12.46	7.87	0.468	8.86	1.08	9.46	5.62	9.02	5.37	0.423
	30AWH012H--	7.86	7.86	7.86	17.04	17.04	17.04	0.375	16.62	7.26	19.92	6.89	12.23	5.12	0.794	15.12	6.61	18.12	4.94	7.43	4.04	0.722
	30AWH015H--	7.65	7.65	7.65	20.06	20.06	20.06	0.365	19.77	7.07	22.16	7.31	14.41	5.86	0.945	17.98	6.43	20.16	5.33	8.67	4.62	0.859
	30AWH012H--9	7.49	7.49	7.49	19.66	19.66	19.66	0.358	16.26	6.93	22.37	8.43	14.12	5.73	0.777	15.15	6.30	20.36	5.75	8.50	4.53	0.724
	30AWH015H--9	7.65	7.65	7.65	20.06	20.06	20.06	0.365	19.77	7.07	22.16	7.31	14.41	5.86	0.945	17.98	6.43	20.16	5.33	8.67	4.62	0.859

Cooling capacities in accordance with EN14511-3:2011

38AWH units

		Outside air Temperature, °C													
		35							45						
		LWT °C		Qc kW			EER kW/kW			q l/s	Qc kW		EER kW/kW		
		Nom	Min	Max	Nom	Min	Max	Nom	Nom	Min	Max	Nom	Min	Max	Nom
30AWH004H--	5	3.01	0.80	3.13	2.70	4.56	2.66	0.144	2.67	0.66	2.81	2.09	3.45	2.00	0.127
		4.28	0.65	4.94	2.78	5.66	2.53	0.205	3.78	0.51	4.36	2.11	4.28	1.92	0.18
		4.50	0.42	5.32	2.84	3.41	2.74	0.215	3.91	0.36	4.63	2.03	2.44	1.96	0.187
		9.60	3.46	10.85	2.78	3.16	2.56	0.459	8.38	2.95	9.49	2.02	2.31	1.89	0.401
		12.45	3.40	12.87	2.75	3.29	2.68	0.595	9.24	2.90	9.45	2.20	2.41	2.16	0.441
		9.60	3.33	13.00	2.79	3.22	2.63	0.459	8.88	2.84	9.55	2.38	2.36	2.12	0.424
		12.45	3.40	12.87	2.75	3.29	2.68	0.595	9.24	2.90	9.45	2.20	2.41	2.16	0.441
30AWH004H--	7	3.30	0.89	3.45	2.91	4.92	2.84	0.158	2.91	0.75	3.05	2.23	3.70	2.16	0.139
		4.70	0.73	5.33	2.91	5.96	2.66	0.225	4.15	0.59	4.69	2.21	4.47	2.05	0.198
		5.00	0.50	5.80	3.01	3.85	2.91	0.239	4.37	0.44	5.06	2.17	2.77	2.09	0.209
		10.20	3.83	11.67	2.91	3.43	2.66	0.487	8.68	3.26	9.93	2.14	2.48	1.98	0.415
		13.00	3.75	13.55	2.91	3.67	2.83	0.621	9.82	3.20	10.09	2.30	2.64	2.27	0.469
		10.20	3.68	13.69	3.00	3.59	2.77	0.487	9.33	3.13	10.19	2.56	2.59	2.22	0.446
		13.00	3.75	13.55	2.91	3.67	2.83	0.621	9.82	3.20	10.09	2.30	2.64	2.27	0.469
30AWH004H--	10	3.74	1.03	3.93	3.22	5.46	3.12	0.179	3.28	0.87	3.41	2.45	4.06	2.40	0.157
		5.33	0.86	5.92	3.10	6.40	2.85	0.255	4.71	0.70	5.18	2.35	4.76	2.24	0.225
		5.77	0.63	6.52	3.25	4.50	3.15	0.276	5.04	0.55	5.70	2.37	3.28	2.29	0.241
		11.10	4.39	12.88	3.10	3.85	2.81	0.53	9.14	3.73	10.59	2.31	2.73	2.11	0.437
		13.82	4.29	14.58	3.16	4.23	3.04	0.66	10.70	3.65	11.04	2.45	3.00	2.43	0.511
		11.10	4.20	14.72	3.31	4.15	2.98	0.53	10.00	3.57	11.15	2.84	2.94	2.38	0.478
		13.82	4.29	14.58	3.16	4.23	3.04	0.66	10.70	3.65	11.04	2.45	3.00	2.43	0.511
30AWH004H--	15	4.46	1.26	4.73	3.74	6.36	3.59	0.213	3.88	1.08	4.00	2.82	4.67	2.80	0.186
		6.37	1.07	6.90	3.42	7.14	3.16	0.304	5.64	0.89	6.01	2.60	5.25	2.55	0.27
		7.04	0.84	7.72	3.66	5.58	3.56	0.336	6.17	0.74	6.77	2.70	4.12	2.62	0.295
		12.60	5.32	14.91	3.42	4.53	3.06	0.602	9.89	4.52	11.69	2.59	3.15	2.32	0.473
		15.18	5.18	16.28	3.56	5.18	3.39	0.725	12.16	4.40	12.62	2.70	3.59	2.70	0.581
		12.60	5.08	16.45	3.84	5.08	3.32	0.602	11.12	4.31	12.75	3.30	3.52	2.64	0.531
		15.18	5.18	16.28	3.56	5.18	3.39	0.725	12.16	4.40	12.62	2.70	3.59	2.70	0.581
30AWH004H--	18	4.90	1.40	5.22	4.05	6.89	3.86	0.234	4.25	1.20	4.36	3.03	5.04	3.03	0.203
		7.00	1.20	7.49	3.61	7.58	3.35	0.334	6.20	1.00	6.50	2.74	5.54	2.74	0.296
		7.80	0.97	8.44	3.90	6.24	3.80	0.373	0.85	0.85	0.85	4.62	4.62	4.62	0.041
		13.50	5.88	16.12	3.61	4.95	3.21	0.645	10.34	4.99	12.35	2.76	3.40	2.45	0.494
		16.00	5.72	17.31	3.81	5.75	3.60	0.764	13.03	4.85	13.57	2.86	3.94	2.86	0.623
		13.50	5.60	17.48	4.15	5.63	3.53	0.645	11.80	4.75	13.70	3.58	3.86	2.80	0.564
		16.00	5.72	17.31	3.81	5.75	3.60	0.764	13.03	4.85	13.57	2.86	3.94	2.86	0.623

Legend

LWT - Leaving Water Temperature, °C
 Qc - Cooling Capacity, kW
 Nom - Nominal
 Min - Minimum
 Max - Maximum
 EER - Energy Efficiency Ratio, kW/kW
 q - Evaporator water flow rate, l/s

Application Data

Standard units, refrigerant: R-410A
 Evaporator entering/leaving water temperature difference: 5 K
 Evaporator fluid: Water
 Fouling Factor: 0.m² K/W

Performance in accordance with EN 14511-3:2011

Hydronic module

The hydronic module reduces the installation time. The unit is factory-equipped with the main hydronic components required for the installation: water pump, expansion tank, safety valve and pressure gauge.

The water heat exchanger and the hydronic module are protected against frost down to -10 °C, using pump cycling. The hydronic module is integrated into the unit without increasing its dimensions and saves the space normally used for the water pump.

Hydronic components

30AWH - H models

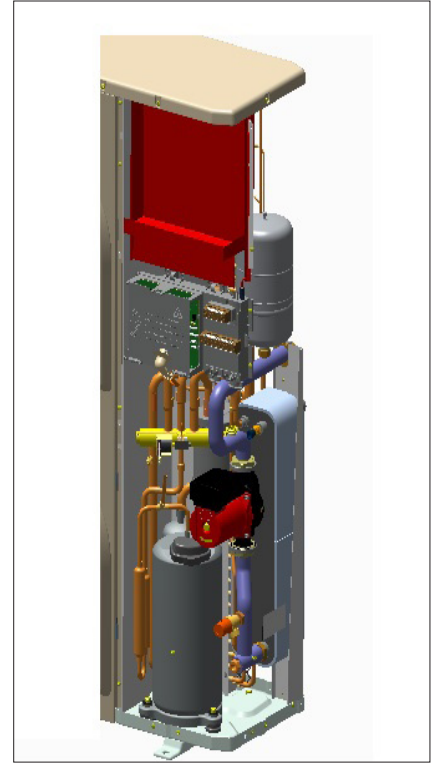
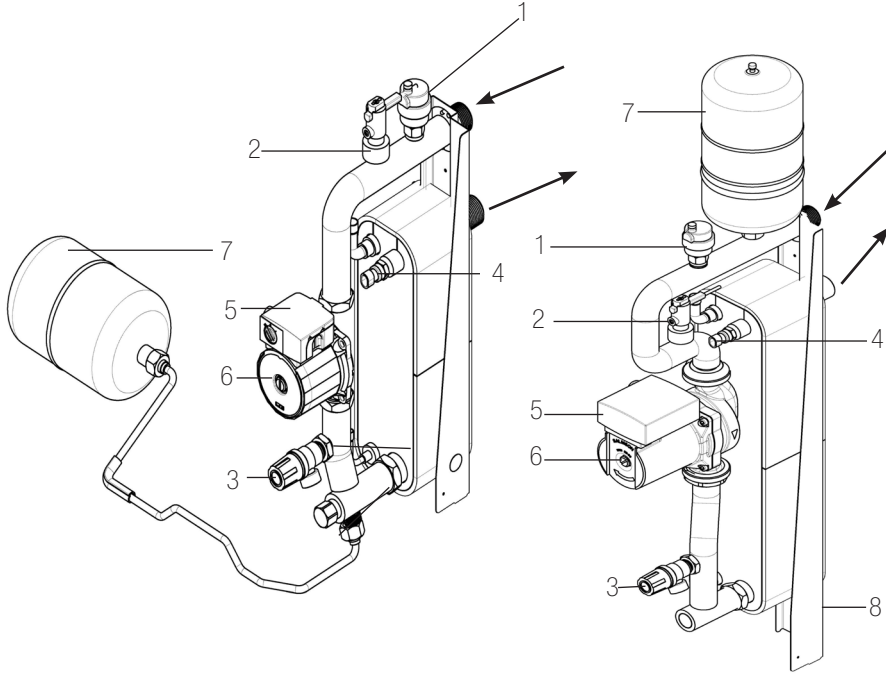

30AWH - X models

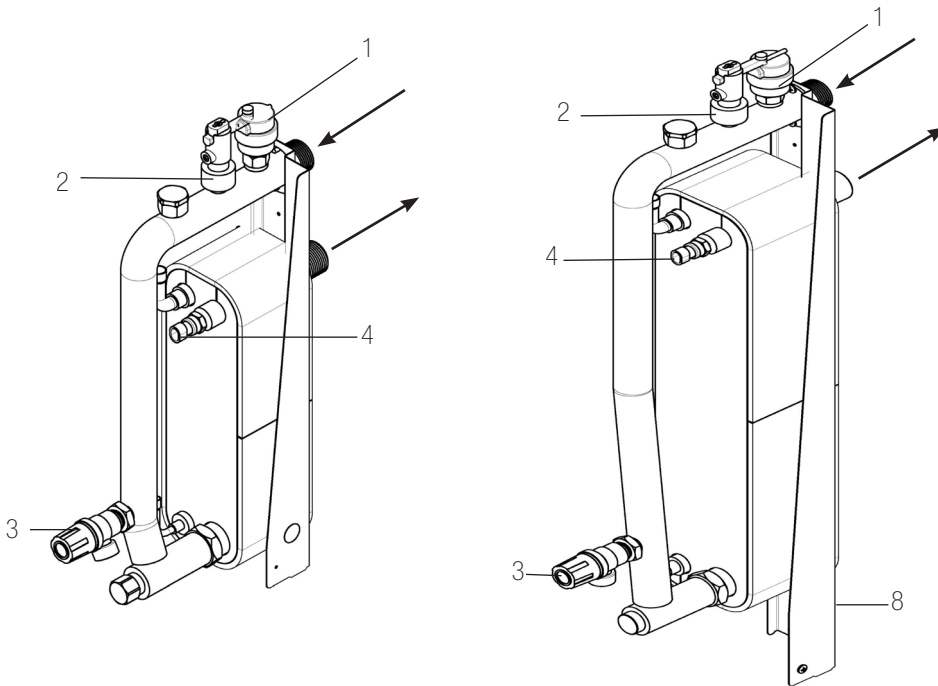

Legend

- 1 Automatic purge valve
- 2 Water flow switch
- 3 Pressure relief valve
- 4 Water temperature sensors
- 5 Water circulation pump
- 6 Plug to unblock the pump
- 7 Expansion tank
- 8 Water drain cap

Suggested hydronic circuit installation

30AWH - H models

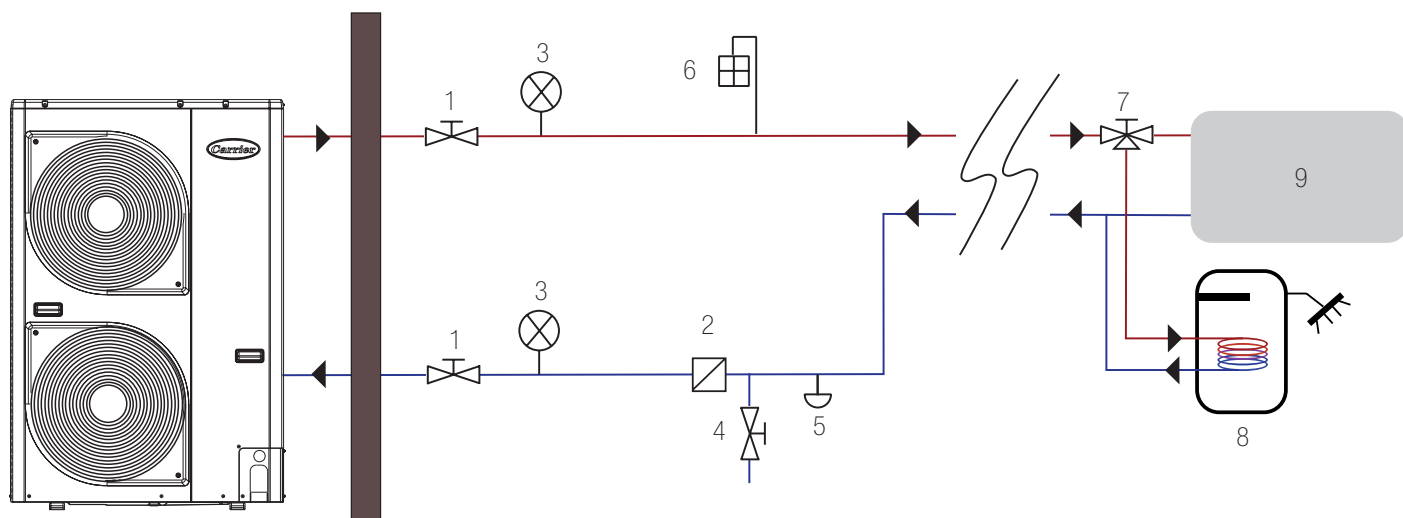

30AWH - X models

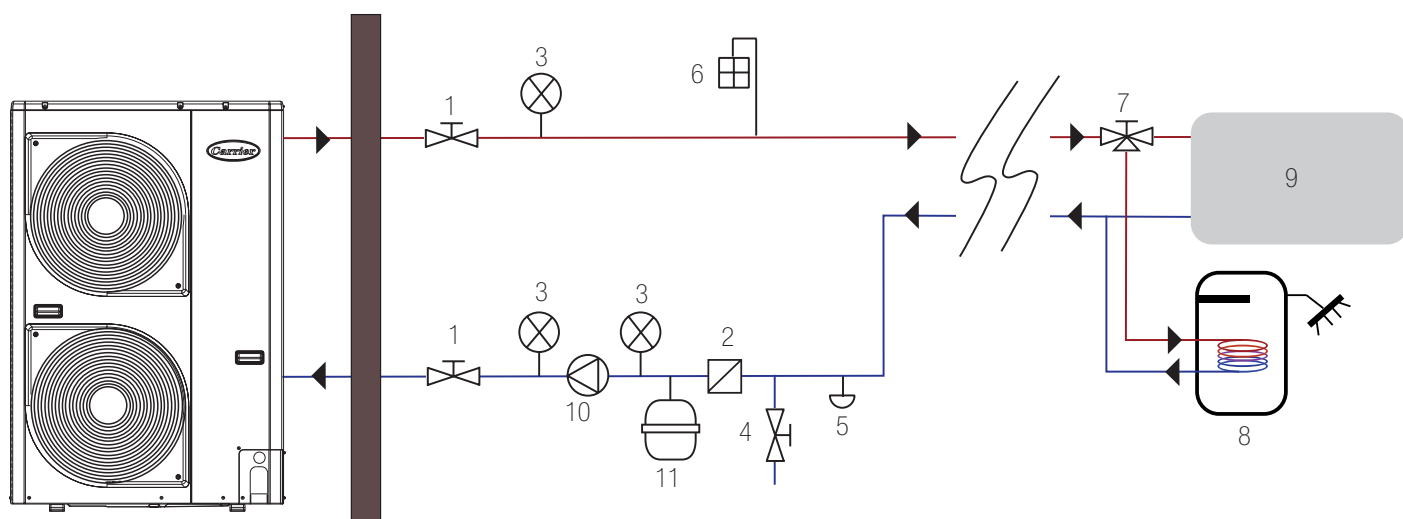

Legend

- 1 Ball valve
- 2 Water filter (10 mesh/inch)
- 3 Pressure gauge
- 4 Charge valve
- 5 Drain valve (located at the lowest water circuit point)
- 6 Purge valve (located at the highest water circuit point)
- 7 Three-way valve
- 8 Domestic hot water tank
- 9 Terminals (fan coil units, underfloor heating, radiators)
- 10 Water pump
- 11 Expansion tank



Order No.: 13469-20, 10.2013. Supersedes order No.: 13469-20, 05.2013.
Manufacturer reserves the right to change any product specifications without notice.



Manufactured by: Carrier SpA, Villasanta, Italy.
Printed in the European Union.